







**WRCG60RF / 90RF**  
**WRCG60RFBK / 90RFBK**

User Manual

---



---

	Before you start	03
	Safety	03
	Electrical installation	06
	Technical data	07
	Troubleshooting	09
	Guarantee	10
	What's required for installation	12
	What's in the box	12
	Installation	13
	Connectivity	22
	Use	24
	Functions & Settings	24
	Care & Maintenance	26
	Service & Spares	28

---



## | Before you start

These instructions are for your safety. Please read the following instructions carefully before proceeding with the installation and use of this appliance.

**WARNING: All installation work must be carried out by a suitably qualified person, strictly following local building regulations and these instructions.**

- To avoid the risks that are always present when you use an electrical appliance it is important that this cooker hood is installed correctly and that you read the safety instructions carefully to avoid misuse and hazards. After unpacking the cooker hood please check that it is not damaged. If in doubt, do not use the appliance and contact Customer Services.
- Check the package and make sure you have all of the parts listed and decide upon the appropriate location for your product. If this product contains glass please take care with fitting or handling to prevent personal injury or damage to the product. The specification plate shown on this appliance displays all the necessary identification information for ordering replacement parts. If you sell the appliance, give it away, or leave it behind when you move house, please ensure that you pass on this manual so that the new owner can become familiar with the appliance and its safety warnings.

## | Safety

**There is a risk of electric shock and fire if cleaning is not carried out in accordance with these instructions.**

**Where applicable, this hood is supplied with fixings. Please ensure you use the correct fixings suitable for the substrate where the hood will be installed and that they are able to support the weight of the hood.**

**Use only the same size of fittings and mounting screws as recommended in this instruction manual. Failure to follow these instructions may result in electrical hazards.**

**Switch off the hood at the mains supply before carrying out any maintenance work or cleaning.**

**Accessible parts may become hot when used with cooking appliances. Children less than 8 years of age shall be kept away unless continuously supervised and care should be taken to avoid touching the appliance.**

**Do not flambé under the hood. To avoid the risk of fire, clean or replace the grease filter regularly and closely monitor pans containing hot oil.**



---

| Safety (continued)

---

**Means for full disconnection must be incorporated in the fixed wiring in accordance with the local wiring installation rules for your country. An all-pole disconnection switch having a contact separation of at least 3mm in all poles should be connected during installation.**

---

**When the hood is located above an appliance, please refer to dimension A in Step 2 of the installation diagram for the minimum distance between the supporting surface for the cooking vessels on the hob and the lowest part of the hood.**

---

**Before connecting the hood, check that the supplied voltage and frequency match with that indicated on the appliance rating plate. Failure to install the appliance in accordance with these instructions may result in a safety hazard. If in doubt, ask for advice instore or from a qualified installer.**

---

**Consult local regulations regarding extraction outlets and ensure these are complied with. Do not connect the hood to a ventilation or hot air duct containing combustion fumes from burning gas or other fuels. Confirm that room ventilation is appropriate with the local authorities.**

---

---

**The hood may stop working during an electrostatic discharge (e.g. lightning). This involves no risk of damage. Switch off the electricity supply to the hood and reconnect after one minute.**

---

**This hood can be used by children aged from 8 years and above and persons with reduced physical, sensory or mental capabilities or lack of experience and knowledge if they have been given supervision or instruction concerning use of the appliance in a safe way and understand the hazards involved. Children shall not play with the hood. Cleaning and user maintenance shall not be made by children without supervision. Keep the hood and its supply cord out of the reach of children less than 8 years old.**

---



### | Safety (continued)

- Do not install the appliance outdoors in a damp place or in an area which may be prone to water leaks such as under or near a sink unit. In the event of a water leak affecting the appliance, do not use and contact customer services to arrange for inspection.
- Do not use flammable sprays in close vicinity to the appliance.
- If the supply cord is damaged, it must be replaced by the manufacturer, its service agent or similarly qualified persons in order to avoid a safety hazard.
- Please dispose of the packing material carefully. There is a fire risk if cleaning is not carried out in accordance with the instructions. Refer to the Care and Maintenance sections carefully for details on how to clean and replace the aluminium and carbon filters (if fitted).
- The LED lamps in this appliance are not replaceable by the consumer. If a lamp fails, please contact the customer helpline at the end of Care & Maintenance to arrange an engineer visit.
- Do not use a steam cleaner for care and maintenance.
- The appliance is not intended to be operated by means of an external timer or separate remote control system.
- There shall be adequate ventilation of the room when the hood is used at the same time as appliances burning gas or other fuels. Ensure that the negative pressure of the installation site does not exceed 4 Pa (0.04 mbar) to ensure combustion fumes are not drawn back into the room.
- Do not use the hood if it shows signs of damage or imperfection. Contact customer services for assistance.
- The manufacturer declines all liability for personal or material damage as a result of misuse or incorrect installation of this appliance.
- The appliance is for domestic use only as an extractor hood.



## | Electrical installation

All installation must be carried out by a competent person or qualified electrician. Before connecting to the mains supply ensure that the mains voltage corresponds to the voltage on the rating plate.

### Direct Connection

The appliance must be connected directly to the mains using an omnipolar circuit breaker with a minimum opening of 3mm between the contacts.

The installer must ensure that the correct electrical connection has been made and that it complies with the wiring diagram.

The cable must not be bent or compressed.

Regularly check the power plug and power cord for damage. If the supply cord is damaged, it must be replaced by a special cord or assembly available from the manufacturer or its service agent.

To avoid the risks that are always present when you use an electrical appliance it is important that this appliance is installed correctly and that you read the safety instructions carefully to avoid misuse and hazards. Please keep this instruction booklet for future reference and pass it on to any future owners. After unpacking the appliance please check that it is not damaged. If in doubt, do not use the appliance and contact Customer Services.

The manufacturer declines all liability for damage caused to persons and objects due to incorrect or improper installation of the appliance. Any permanent electrical installation must comply with the latest wiring regulations applicable to your country and for your own safety a qualified electrician or contractor should undertake the electrical installation.

The appliance is supplied from the factory to use external ducting (not supplied). Should you wish to use this in recirculation mode only, please fit the correct carbon filter (not supplied).



**WARNING: This is a Class I appliance and MUST be earthed.**

This appliance is supplied with a 3 core mains cable coloured as follows:

Brown = L or Live

Blue = N or Neutral

Green and Yellow = E or Earth 

### Double Pole Switched Fused Spur Outlet

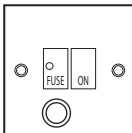

**USE A 3AMP FUSE**



**| Technical data**

Supply voltage	220-240V~ 50Hz
Power consumption - Fan	90W
Power consumption - Cooking Light	1 x 3W Max
Power consumption - Ambient Light	1 x 2W
Power consumption - Total	95W
Protection class	I
ILCOSD Code - Cooking Light	DSL-3-S-385mm x 10mm
ILCOSD Code - Ambient Light	DSS-2-S-725mm x 5mm
Frequency band	434 MHz

Information for EU No. 66/2014 and No. 65/2014 A.  
Information of the cooker hood.

<b>Trademark</b>	<b>Value</b>
Model identification	WRCG60RF/60RFBK WRCG90RF/90RFBK
Annual Energy Consumption (AEC hood) (kWh/year)	21.2
Energy Efficiency class	A+
Fluid Dynamic Efficiency	31.7
Fluid Dynamic Efficiency class	A
Lighting Efficiency (LEhood) (lux/W)	WRCG60RF/60RFBK 14.2
	WRCG90RF/90RFBK 13
Lighting Efficiency class	D
Grease Filtering Efficiency (GFE hood)	66.3
Grease Filtering Efficiency class (GFEhood)	D
Minimum air flow at working point (in normal use) (m3/h)	190
Maximum air flow at working point (in normal use) (m3/h)	387.8
Maximum air flow at highest setting (Qmax) (m3/h)	401.8
Maximum air flow at highest setting (Qmax) (m3/h) (with Boost)	600
Weighted sound power level at minimum setting (LWA) (dB)	46
Weighted sound power level at maximum setting (LWA) (dB)	63
Sound power level of boost if any (LWA) (dB)	70
Measured power consumption off mode (Po) (W)	0.4
Measured power consumption in standby mode (Ps) (W)	-



| **Technical data**

Time increase factor (f)	0.9
Energy Efficiency Index (EElhood)	44.7
Measured air flow rate at best efficiency point (QBEP) (m3/h)	237.2
Measured air pressure at best efficiency point (PBEP) (Pa)	255
Measured electric power input at best efficiency point (WBEP) (W)	53
Nominal power of the lighting system (WL) (W)	5
Average illumination of the lighting system on the cooking surface (Emiddle) (lux)	WRCG60RF/60RFBK 71
	WRCG90RF/90RFBK 65

The measurement and calculation method of the above table was done in accordance with Commission Delegated Regulation (EU) No 65/2014 & Commission Regulation (EU) No 66/2014.

**B. The following shows how to reduce total environmental impact (e.g. energy use) of the cooking process.**

1. Install the cooker hood in a proper place where there is efficient ventilation.
2. Clean the cooker hood regularly so as not to block the airway.
3. Remember to switch off the cooker hood light after cooking.
4. Remember to switch off the cooker hood after cooking.

**C. Information for dismantling.**

This appliance cannot be dismantled by the user, other than that as shown in the original assembly of the user manual.

At the end of its useful life, the appliance should not be disposed of with household waste. Check with your local governmental authority, domestic waste disposal services or the retailer where the product was bought for recycling advice.



**| Troubleshooting**

<b>Problem</b>	<b>Possible cause</b>	<b>Solution</b>
Excessive vibration.	The appliance is not installed properly on the brackets.	Take down the appliance and check it is properly fixed.
	The fan blade is damaged.	Switch off the appliance. Repair to be carried out by qualified service personnel only.
	The fan motor is not fixed tightly.	
The light is on, but the fan does not work.	The fan blade is jammed.	Repair to be carried out by qualified service personnel only.
	The motor is damaged.	
Both the light and motor do not work.	Light bulb blown.	Ring the customer helpline at the end of the Care & maintenance section to arrange an engineer visit.
	Power connection loose.	Check power supply.
Suction performance reduced.	Speed may be too low.	Select a higher speed.
	Aluminium filters are dirty.	Clean the aluminium filters. (See Care and maintenance section).
	Top vent might be obstructed.	Clear any obstruction.
	Optional vent kit might be twisted.	Ensure that the vent kit is fitted according to the manufacturer's instructions.
	The installation may not comply with the manufacturers instructions.	The vent hose should be correct diameter throughout with no reductions or restriction. (See installation section).
Works normally but cooking smells linger.	Carbon filter is not fitted in recirculation mode or is full of grease.	Fit carbon filter or replace the carbon filter (See Care and maintenance section).

This appliance respects laws of the suppression of radio interference. As the Manufacturer has a policy of continuous product improvement, it reserves the right to adapt and carry out any modification considered necessary without prior warning.



## | Declaration of Conformity

## | Declaration of Conformity

### (EU) Declaration of Conformity

### (UK) Declaration of Conformity

Name and address of the manufacturer or his authorised representative:

Name and address of the manufacturer or his authorised representative:

AAUK Ltd  
Unit 3 Normandy Landings  
Pope Street, Castleford  
West Yorkshire  
WF6 2AG

AAUK Ltd  
Unit 3 Normandy Landings  
Pope Street, Castleford  
West Yorkshire  
WF6 2AG

This declaration of conformity is issued under the sole responsibility of the manufacturer.

This declaration of conformity is issued under the sole responsibility of the manufacturer.

Object of the declaration:

Object of the declaration:

- **Product: Curved Glass Hood**
- **Model: WRCG60RF**
- **Model: WRCG90RF**
- **Model: WRCG60RFBK**
- **Model: WRCG90RFBK**

- **Product: Curved Glass Hood**
- **Model: WRCG60RF**
- **Model: WRCG90RF**
- **Model: WRCG60RFBK**
- **Model: WRCG90RFBK**

The object of the declaration described above is in conformity with the relevant Union harmonisation legislation:

The object of the declaration described above is in conformity with the relevant legislation:

- 2014/53/EU as amended  
Radio Equipment Directive

- Radio Equipment Regulations 2017  
as amended

References to the relevant harmonised standards used or references to the other technical specifications in relation to which conformity is declared:

References to the relevant designated standards used or references to the other technical specifications in relation to which conformity is declared:

- EN 60335-1:2012 + A11:2014 + A13:2017 + A1:2019 + A14:2019 + A2:2019 + A15:2021
- EN 60335-2-31:2014
- EN 62233:2008
- EN 55014-1:2017 + A11:2020
- EN 55014-2:2015
- EN 61000-3-3:2013 + A1:2019
- EN 300 220-2 V3.1.1:2017-02
- EN 301 489-3 V2.1.1:2019-03
- EN 301 489-1 V2.2.3:2019-11
- EN 62479: 2010
- EU No 66/2010

- EN 60335-1:2012 + A11:2014 + A13:2017 + A1:2019 + A14:2019 + A2:2019 + A15:2021
- EN 60335-2-31:2014
- EN 62233:2008
- EN 55014-1:2017 + A11:2020
- EN 55014-2:2015
- EN 61000-3-3:2013 + A1:2019
- EN 300 220-2 V3.1.1:2017-02
- EN 301 489-3 V2.1.1:2019-03
- EN 301 489-1 V2.2.3:2019-11
- EN 62479: 2010
- EU No 66/2010
- BS EN 60335-1:2012 + A15:2021
- BS EN 60335-2-31:2014
- BS EN 62233:2008
- BS EN 55014-1:2017 + A11:2020
- BS EN 55014-2:2015
- BS EN 61000-3-3:2013 + A1:2019



---

## | Recycling & disposal



Waste electrical products (WEEE) should not be disposed of with household waste.

Please recycle where facilities exist. Check with your local governmental authority, domestic waste disposal services or the retailer where the product was bought for recycling advice.

The wheelee bin symbol on the product or its packaging indicates that this product cannot be treated as normal household waste. This product must be handed over to an electric and electronic equipment collection point for recycling.

On ensuring that this product is disposed of correctly, you will help to avoid possible negative consequences for the environment and public health, which could occur if this product is not handled correctly.

---



### | What's required for installation

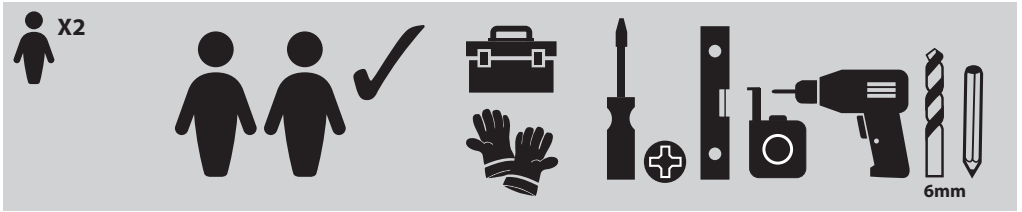

### | What's in the box

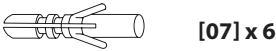
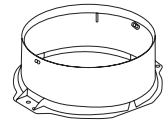
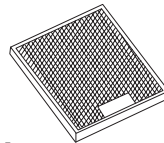
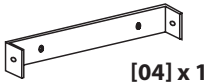
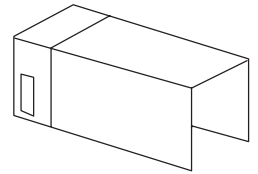
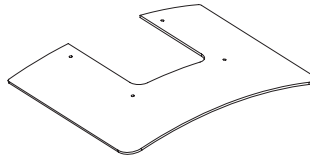
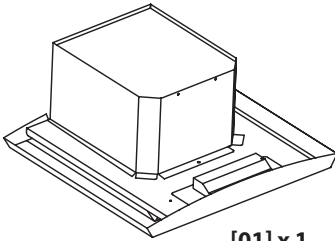

### Not included

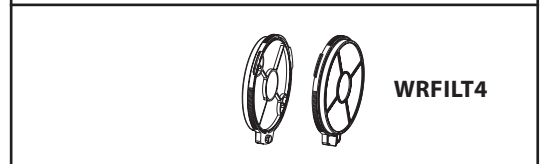
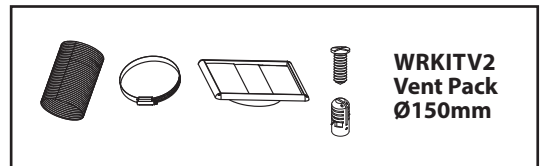



| Choose a type of installation

# 01



**A** DUCTED OPTION  
(extraction to the outside)

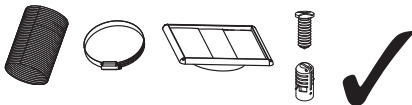
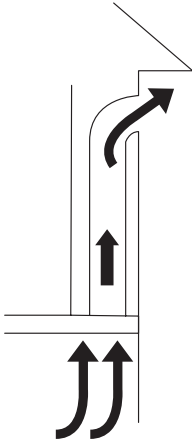

WRKITV2 Vent Pack Ø150mm

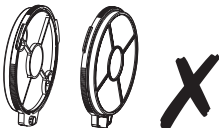

**B** RECIRCULATION OPTION  
(no extraction to the outside).  
This appliance is for installation  
on a wall only.

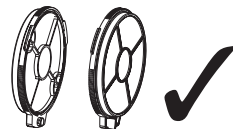
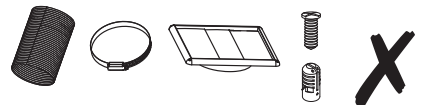
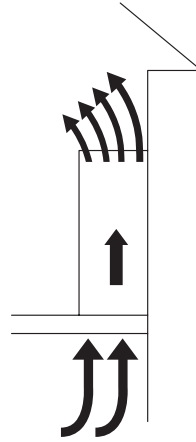

WRFILT4



| Mark the wall with the hole positions

02

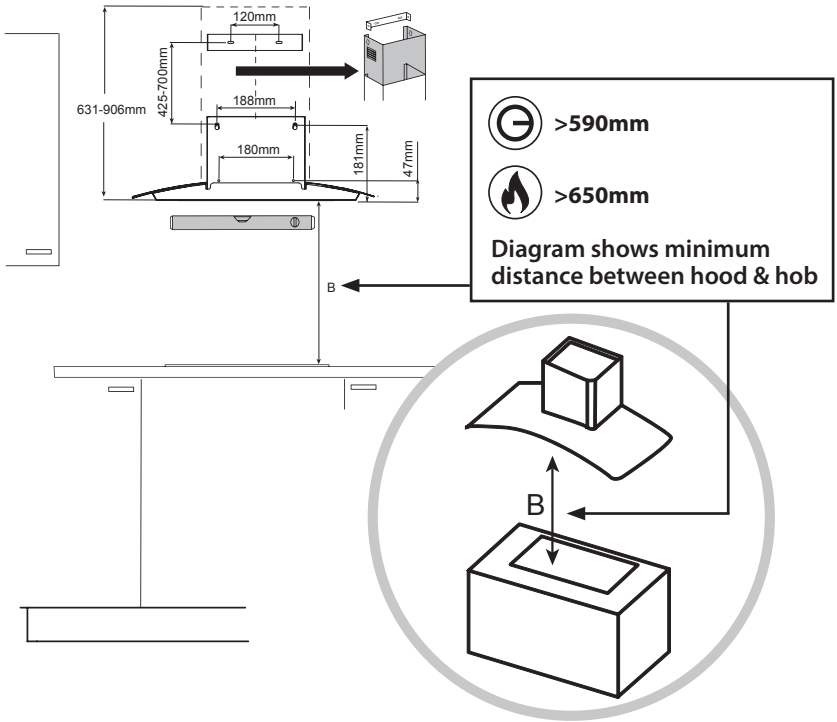

Mark the wall with the hole positions as shown in the diagram. The fixings supplied are suitable for solid walls only. When fixing to any other type of wall use suitable alternative fixings.

Drill the holes, insert the wall plugs in all 8 holes. Insert the screws in the holes in the second row from the bottom. The maximum gap between row three and row four from the bottom should be between 425-700mm, dependent upon the ceiling height.

**Warning: Caution! Before drilling it is extremely important to check the wall for hidden pipes, electrical cables etc using an appropriate detection device.**

**WARNING: Use only the same size of fittings and mounting screws as recommended in this instruction manual. Failure to follow these instructions may result in electrical hazards.**

**WARNING: Please follow the Safety and Electrical Installation sections at the start of this manual before connecting this appliance to the mains supply!**



# 03



[07] x 6



[08] x 2  
4 X 32mm

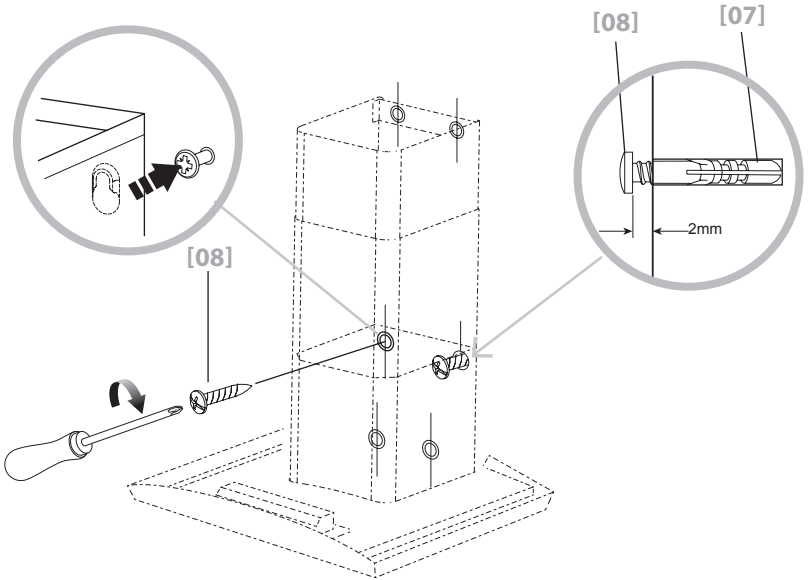

# 04



[04] x 1



[08] x 2  
4 X 32mm

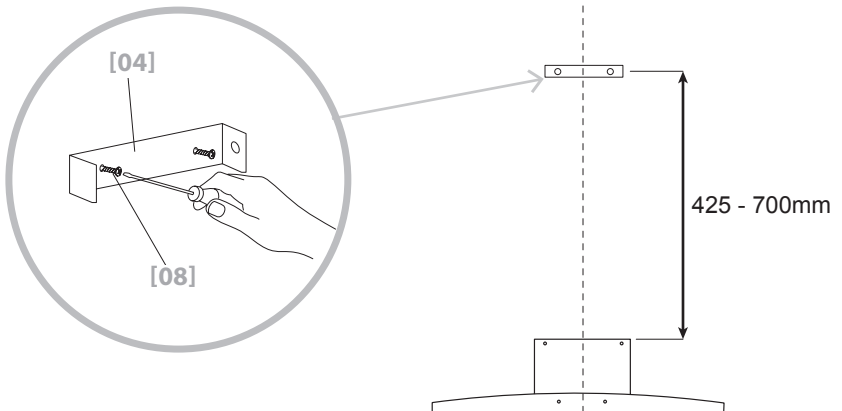



# 05



[08] x 2  
4 X 32mm

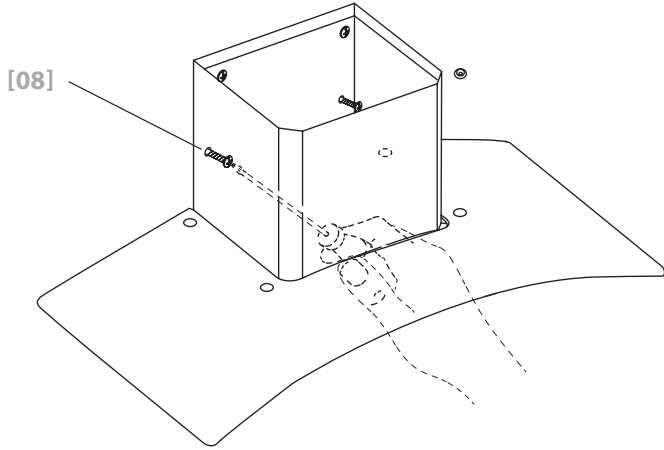

# 06



[02] x 1



[10] x 4



[11] x 4



[12] x 4



[13] x 1

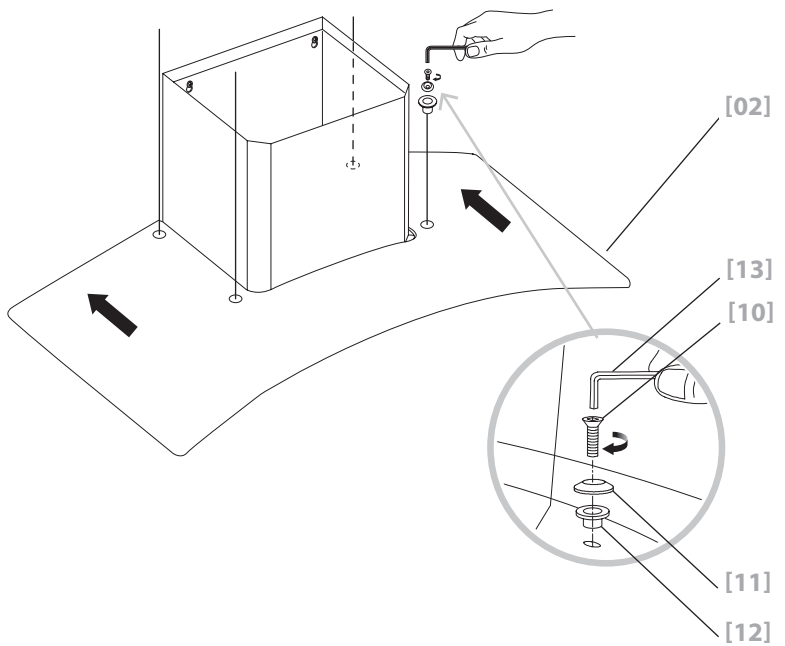

Tighten all screws (do not over tighten).





07



A

DUCTED OPTION  
(extraction to the outside)

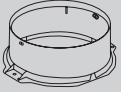

[06] x 1



[09] x 2  
3.5 x 10mm

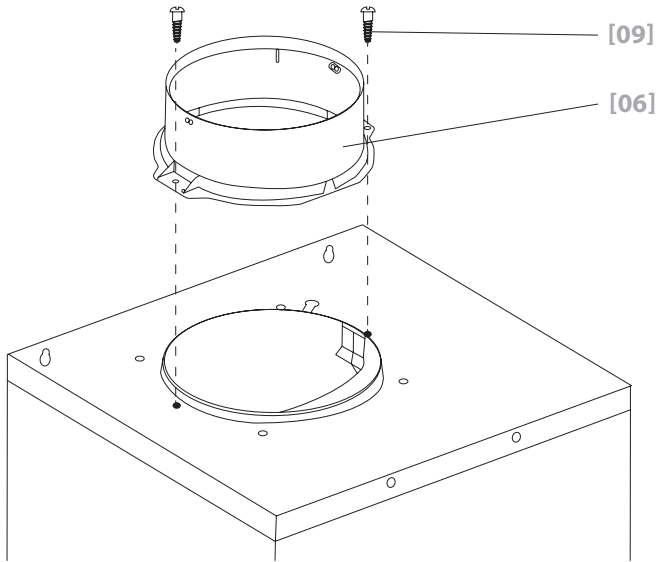



# 08



**A**

**DUCTED OPTION**  
(extraction to the outside)

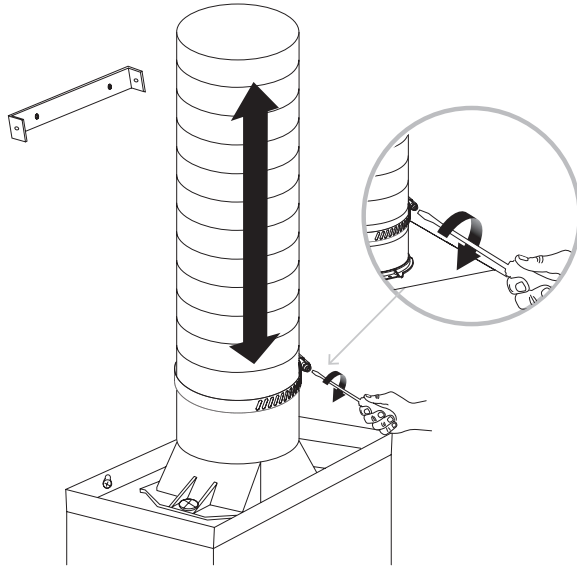
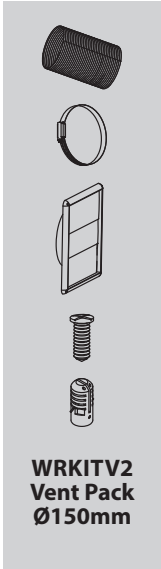

# 09



**A**

**DUCTED OPTION**  
(extraction to the outside)

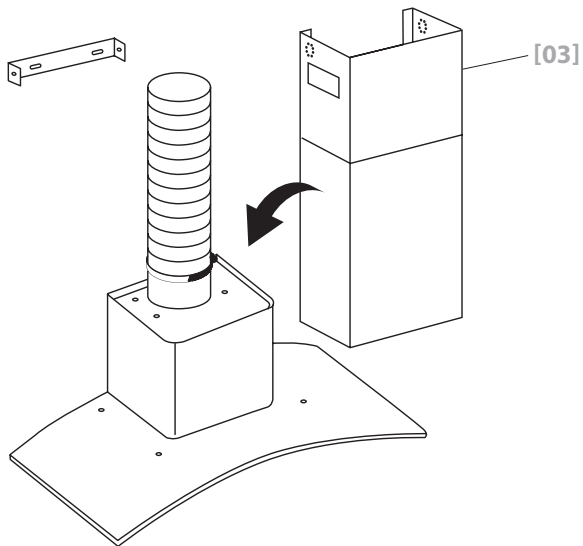
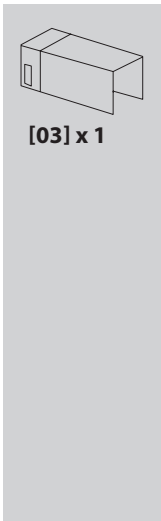



10



**B** RECIRCULATION OPTION  
(no extraction to the outside)

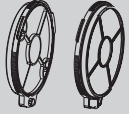

WRFILT4

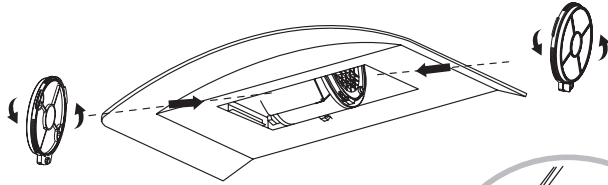

WRFILT4

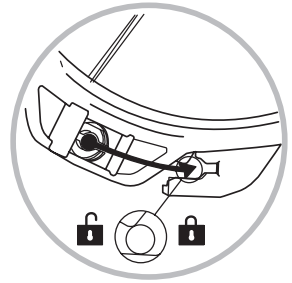
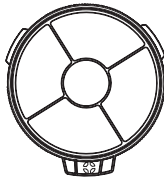

11



**B** RECIRCULATION OPTION  
(no extraction to the outside)

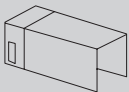

[03] x 1

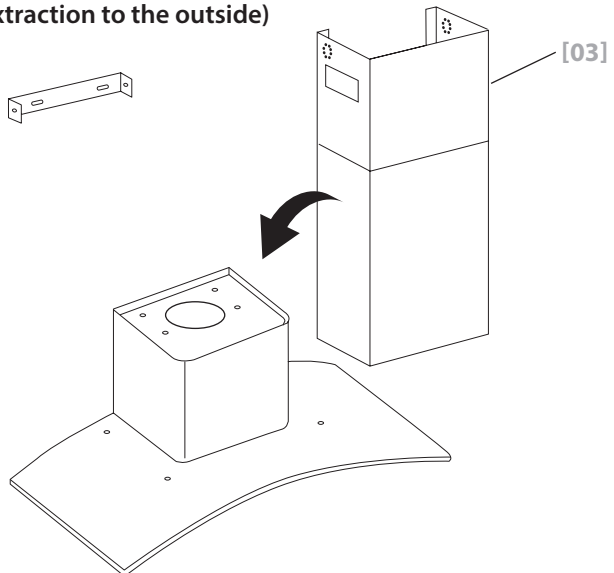
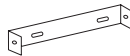



12



**A**

**DUCTED OPTION**  
(extraction to the outside)



**B**

**RECIRCULATION OPTION**  
(no extraction to the outside)



[09] x 2  
3.5 x 10mm

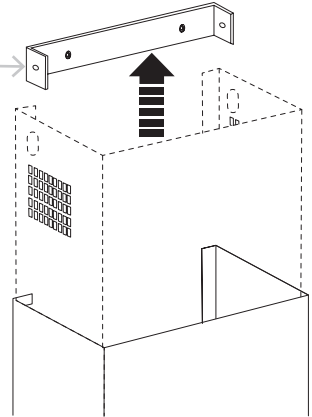
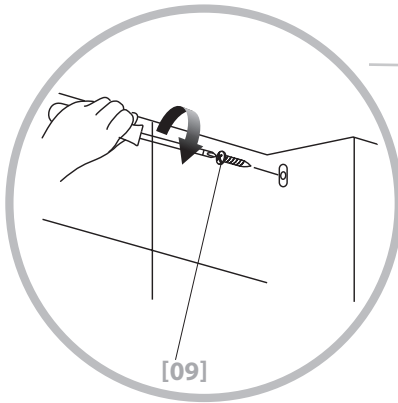



# 13

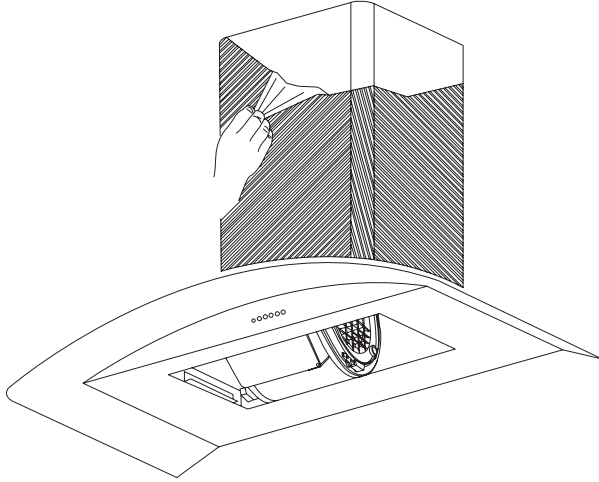

Stainless steel only.

# 14

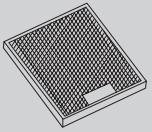

[05] x 1

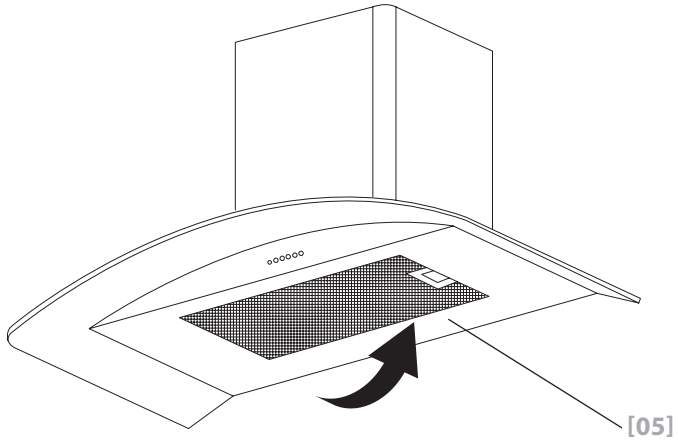



[05]



## | Connecting a Viceroy hood with a Viceroy hob

**IMPORTANT: The connectivity operation must be completed within 2 minutes of turning on the power to the hood. If this is not successful, switch off both the hood and the hob, wait for one minute and attempt the connectivity again.**





### Setting up a new linking method

1. Make sure that the hob and the hood is off.
2. Touch the Timer Key  and the Light On/Off Key  on the hood control panel simultaneously. LED light on the hood control panel will be flashing white.



3. Turn on the hob and make sure the Connectivity Indicator lamp is lit up red. 

**Note: Touch the Connectivity Key if the Connectivity Indicator is off.** 

4. Press the keys  and  together on the hob and the connection indicator will flash to confirm connection.
5. The control panel of the hood will show 'A' for 5 seconds to indicate connectivity has been made with the hob.
6. Press the keys  and  together on the hob one more time to store the connectivity settings.



## | Using the connectivity function

Ensure the Connectivity Indicator is lit on the hob control panel.

**IMPORTANT: The extraction rate of the hood will vary based upon the total power output selected on the hob, as shown in the table below. Each hob cooking zone has a maximum rated output of 10 comprising 1-9 and Boost (10).**

Speed Level of the Hood	Combined Power Output of the Hob
Speed 1	This speed will be selected when the combined output is 5 or less.
Speed 2	This speed will be selected when all four cooking zones are in use, and the combined output is between 6 and 10.
Speed 3	This speed will be selected when all four cooking zones are in use, and the combined output is between 11 and 15.
Speed 4	This speed will be selected when all four cooking zones are in use, and the combined output is between 16 and 21.
Speed 5	This speed will be selected when all four cooking zones are in use, and the combined output is between 22 and 27.
Speed P – Boost	This speed will be selected when all four cooking zones are in use, and the combined output is greater than 27.

If the hood controls are manually overridden when the hob and hood are linked, the hood will operate for 5 minutes on this manual setting before returning to control by the hob.

 | Before you start

**WARNING: Read the instructions before using the appliance.**

Switch on the appliance at the switched fused connection unit. The appliance is ready for use.

## | Functions & Settings

### 01 Four-button panel

To obtain the best results from your cooker hood it is recommended that you leave it switched on for up to 15 minutes after you have finished cooking.

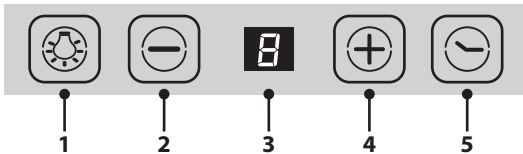

1. Light On/Off
2. Speed Reduction
3. LED Display
4. Speed Increase
5. Timer

#### To Set Up For First Use











**This setting needs to be done within 2 minutes of turning on the mains power (if you need to re-enter Set Up mode disconnect the power and reconnect).**

#### Ducted Option

This is the factory default setting if you are extracting air to the outside.

#### Recirculation Option

This is the option to be used with carbon filters.

1. To change to this option, press both Speed icons   together and the Timer  will flash blue.
2. Press Speed Increase  to change to the Recirculation Option  and the Speed Reduction  to revert back to the Ducted Option .
3. Finally, press both Speed buttons   together one more time to confirm the change and the Timer  will stop flashing.



## 02 General Use



### Light On/Off



- Use this control to switch the light on independently of the fan motor, it will be lit blue in this mode.
- When the fan is in use, and the light is off, the icon will be lit white in this mode, but will turn blue if the light is then switched on.



### Speed Reduction

- Press this icon once to turn on the fan motor at speed 1. All icons will be white and the light icon will be blue if already in use.
- If the motor is on speed 1, pressing and holding this icon for two seconds will turn off the fan motor. As above, the light control is independent of this operation.
- If the motor is higher than speed 1, this will reduce the fan speed with each press of the icon.

### LED Display

- Shows the extraction mode during set up  or  and the motor speeds from 1-5, and **P** for Boost.







### Boost Function and Speed Increase

- Press this icon once to turn on the fan motor at full power, and **P** will flash in the display.
- If the motor is already on speed 1-5, each press of this icon will increase the fan speed accordingly.
- If you press and hold the icon for two seconds, the fan speed will increase to full power and **P** will flash in the display.



## Setting the Timer

- When the fan motor is on and the Timer icon  is pressed, it will be blue and the current speed in the display will start to flash.
- The chosen speed level will remain in use for five minutes before dropping down to the next lowest speed. This speed will remain in operation for two minutes before dropping down again. This will be repeated every two minutes unless the speed is already at level 1 and then the fan will turn off. If the light is already on, this will also be turned off.
- Pressing the Speed Reduction icon  or Speed Increase icon  during a current timer program will restart the countdown process again with a five minute cycle.
- If the Timer icon  is pressed again during a current timer program, the cycle will be cancelled, the icon will revert to white and the current fan speed will remain on indefinitely.
- The maximum timer program cycle is 15 minutes: 5 minutes on **P** and then 2 minutes each on speed 5 down to speed 1.



| Looking after your appliance

**WARNING: Always switch off the electrical supply before carrying out maintenance work on the hood. In the event of a fault, contact customer services.**

**01 Carbon filter replacement**

Replace every three months.



**3 MONTHS**

Replacement Carbon filters WRFILT4 available online at [viceroy.co.uk](http://viceroy.co.uk) or customer helpline in Service & Spares section.

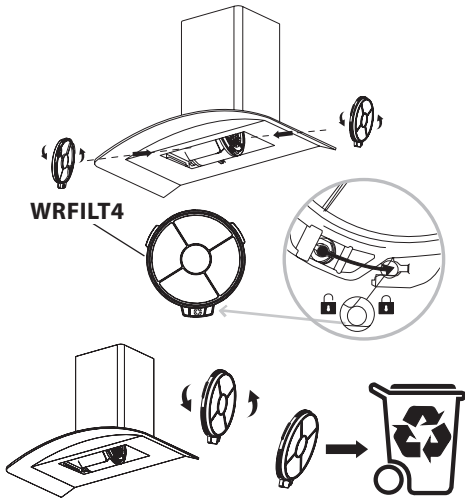

If the motor is off, and after the fan has been in operation for approximately 150 hours, the display will show 

and the Timer will flash blue to advise you to replace the carbon filters. After replacing the filters, reset the alert by pressing the

Timer  icon.



## | Looking after your appliance

### 02 Aluminium grease filter cleaning

Aluminium filters: To avoid fires, clean thoroughly once a month. Remove both grease filters as shown and soak in hot water and detergent for an hour. If using a dishwasher position the filters vertically to improve the cleaning process.



1 MONTH

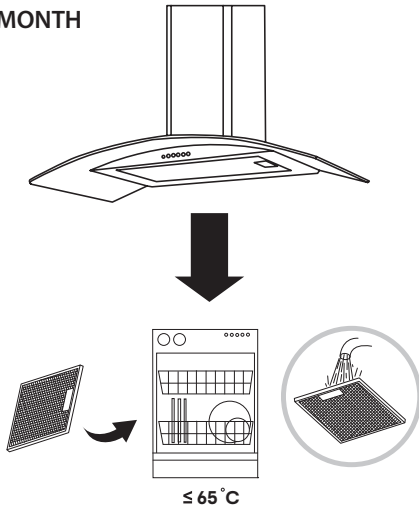

If the motor is off, and after the fan has been in operation for approximately 50 hours, the display will show

and the Timer will flash blue to advise you to clean the aluminium grease filters. After cleaning the filters, reset the alert by pressing the Timer

### 03 Lamp replacement

The LED lamps in this appliance are not replaceable by the consumer. If a lamp fails, please contact the Customer Helpline in the Service & Spares section to arrange an engineer visit.

**WARNING: Increase the filter cleaning/replacement frequency if the hood is used for more than 2 hours a day. Always use genuine filters from the manufacturer.**



---

| After sales & service support



For after sales, service enquiries & spares support

Please contact: **0333 247 1128**

Monday to Friday: 9am-5pm

Saturday: 9am-1pm

Email enquiries: [wrenservice@apelson.co.uk](mailto:wrenservice@apelson.co.uk)

Dedicated spares online at: [viceroy.co.uk](http://viceroy.co.uk)